

ATR-Remote-OLED Control Unit



P/N 600R01-(xxx)-(1xx)

Operation and Installation

(Dokument-Nr. 01.1311.010.71e)

Change History

Revision	Date	Description of Change
1.00	16.05.2011	First release
2.00	04.02.2014	Change of company name to f.u.n.k.e. AVIONICS GmbH
2.01	24.11.2014	Inserted changed setting of Sidetone volume from SW V4.1 in chapter 2.4.6

List of the Service Bulletins (SB)

Services bulletins are to be inserted in the manual and to be put down in this table.

SB Number	Rev. No.	Issue Date	Entry Date	Name

Survey of Variants

Part Number	Description
P/N 600R01-(1xx)-(1xx)	Remote control for ATR833/ATR833A with 2 knobs
P/N 600R01-(2x1)-(1xx)	Sidetone volume is controlled from SW V4.1 via the intercom volume

Contents



1	GENERAL.....	5
1.1	Symbols	5
1.2	Abbreviations	5
1.3	Customer Support	6
1.4	Features.....	6
2	OPERATION.....	7
2.1	Controls.....	7
2.2	ON/OFF	9
2.2.1	Connection Problems	9
2.3	Display	10
2.4	Basic Settings	12
2.4.1	VOL – Volume	13
2.4.2	SQL – Squelch	13
2.4.3	DIM – Display Brightness	14
2.4.4	VOX – Voice Detection (Speech Threshold for Voice Activated Intercom).....	14
2.4.5	DWM – Dual Watch Volume Reduction	15
2.4.6	INT – Intercom-Volume.....	15
2.4.7	EXT – Volume of the External Audio Input.....	16
2.5	Frequency Setting	17
2.5.1	Automatic 8.33 / 25 kHz Channel Width Selection.....	17
2.5.2	Manual Frequency Input.....	18
2.5.3	Recall a Frequency from the User Memory.....	18
2.5.4	Recall a Frequency from the List of the 10 Last Used.....	19
2.5.5	Store a Frequency into the User Memory	20
2.6	Dual Watch Operation	21
2.7	Transmission.....	23
2.8	Reception.....	23
3	CONFIGURATION.....	24
3.1	SPC – Channel Spacing.....	24
3.2	DPY – Energy Saving Mode (Automatic Display Darkening)	25
3.3	EXT – External Audio Input's Behavior.....	26

3.4	Microphone Input Sensitivity (MLS/MLD/MRS/MRD).....	27
3.4.1	MLS – Standard Microphone Pilot/Left	27
3.4.2	MLD – Dynamic Microphone Pilot/Left.....	27
3.4.3	MRS – Standard Microphone Copilot/Right	27
3.4.4	MRD – Dynamic Microphone Copilot/Right.....	27
4	INSTALLATION	29
4.1	Advices and Tips.....	29
4.2	Scope of delivery.....	29
4.3	Unpacking and Inspecting the Equipment	29
4.4	Mounting	30
4.5	Wiring.....	31
4.5.1	Connection Using the Provided Cable Set.....	31
4.5.2	Connections Using	31
4.5.3	Connector Pin Allocations.....	32
4.5.4	Wiring Diagram.....	32
4.6	Post-Installation Check.....	33
4.7	Accessories.....	33
4.8	Drawings	33
4.8.1	Dimensions.....	33
4.8.2	Mounting Advices	34
5	APPENDIX.....	35
5.1	Frequency/Channel-Plan.....	35
5.2	Technical Data	36
5.3	Environmental Conditions	37

1 GENERAL

This manual contains information about the physical, mechanical and electrical characteristics as well as information about installation and operation of the remote control unit ATR600RT for the VHF Com transceivers ATR833/ATR833A with two knobs.

1.1 Symbols

	Advices whose non-observance can cause radiation damage to the human body or ignition of combustible materials.
	Advices whose non-observance can cause damage to the device or other parts of the equipment.
	Information

1.2 Abbreviations

Abb.	Name/subject	Definition
DIM	Dimming	Display Brightness
EXT	External audio input	Volume of external audio signal
INT	Intercom	Volume of board-internal intercom
MIC	Microphone	
PTT	Push-To-Talk	Key to activate radio transmission
SEL	Selection	
SQ	Squelch	Noise suppression radio reception
VOL	Volume	Volume of radio reception
VOX	Voice activation	Volume threshold for voice-activated intercom

1.3 Customer Support

In order to facilitate a rapid return of shipments, please follow the instructions of the input guide “Reshipment RMA” provided at the Service-Area within the f.u.n.k.e. AVIONICS GmbH web portal www.funkeavionics.de.



Any suggestions for improvement of our manuals are welcome. Contact: service@funkeavionics.de.



Informations on software updates are available at f.u.n.k.e. AVIONICS GmbH.

1.4 Features

- Remote Control for controlling VHF COM transceivers
 - ATR833 starting with P/N 833-(200)-(200)
 - ATR833A starting with P/N 833A-(100)-(100)
- Ideal for tandem seated aircraft:
 - Automatic deactivation of remote control on deactivation of radio
 - Use of radio still possible without activation of remote control
- Fully transparent remote control – everybody sees what the other does
- Direct access to the **first 10** frequency memories of the remote controlled radio, including their names
- Easy recall of the 10 last used frequencies
- OLED display for best readability under all viewing angles
- Easy installation – plugin of one connector only.

2 OPERATION

2.1 Controls

Use together to adjust volume, squelch or other setting

SET

Short press:

Choose item to be adjusted with **VOL / SEL**

Very long press:

Access configuration menu

VOL/SEL

Rotary knob

Adjust value or select item given within the display's lower left corner:

Chosen with **SET**:
adjust VOLUME, squelch, etc.

Chosen with **MEM**:
SELEct item from list of frequencies

ON/OFF

(Radio must be on)

DW

Activate / Deactivate dual watch reception of standby frequency

CHANGE

Swap active and standby frequency

CURSOR

Short press:

Set underline to select which value to be changed with **FREQ**

Long press:

In MEM only: add name to memory item

FREQ

Rotary knob

Change underlined value

MEM

Short press:

Access user frequency memory / list of last used frequencies









Long press:

In MEM only: store frequency/name



Use together to change standby frequency

Operation and Installation

	ON/OFF	Switch On press button for approx. 0.5 s Switch Off press button for approx. 2 s
	DUAL WATCH	Activates/deactivates the mode for mutual reception of standby frequency (display shows DW instead of SBY)
	SET	<ol style="list-style-type: none"> 1. Choose item VOL, SQ, VOX, DIM etc. (each adjusted by VOL / SEL) →press button shortly 2. Shortcut to volume setting →press button for at least 1.5 seconds 3. Enter configuration menu →press button for at least 5 seconds
	CURSOR	<ol style="list-style-type: none"> 1. Move underline within standby frequency, to be adjusted by FREQ →press button shortly 2. Add name to frequency within memory →press button for at least 1.5 seconds
	CHANGE	Swap active and standby frequency
	MEM	<ol style="list-style-type: none"> 1. Access user defined frequency list (MEM list). → press button shortly once 2. Access list of 10 last used frequencies (LST list) → press button shortly twice 3. Store active frequency to selected memory (only for MEM list) → press button for at least 1.5 seconds
 VOL / SEL	VOL / SEL Rotary Knob	<ol style="list-style-type: none"> 1. Adjust volume or other item selected by SET (VOL, SQ, VOX, DIM etc.) 2. Select frequency from user memory or list of last used frequencies
 FREQ	FREQ Rotary Knob	Change the underlined value (i.e. adjust standby frequency, or input character when entering name)

2.2 ON/OFF

	<p>The device can only be switched on with the remote controlled radio being on. When switching the radio off, the remote control is automatically switched off.</p>
---	--

Turn the remote control on with **I/O**

On: **I/O** press button for 0.5 s

Off: **I/O** press button for 2 s

After turning on the display shows:

<p>ATR833RT v2.0</p>	<p>Device type ATR833RT – (legal name: ATR600RT)</p> <p>Software version z.B. v2.0</p>
--	--

The boot screen shows the device type and the software version.

The remote control automatically retrieves the current data from the attached radio (message: "SYNCHRONISING").

After that the device changes into normal operation (direct input mode).

2.2.1 Connection Problems

If after being turned on no connection can be made to the attached radio, a message appears:

<p>NO HOST DEVICE DETECTED</p>

In this case the remote control cannot be used. The functionality of the attached radio, however, is not affected in any way.

Operation and Installation

2.3 Display

Use of active frequency:

TX = transmitting

RX = receiving

Te = timeout (release and push again

PTT key to re-enable transmissions)

Cursor marking:

Set position with , adjust value with **FREQ**

Fixed label for active frequency

Label for standby frequency:

DW = dual watch active

SBY = no dual watch

Item chosen by **SET**, or when accessing frequency list: Adjust value or select number with **VOL / SEL**

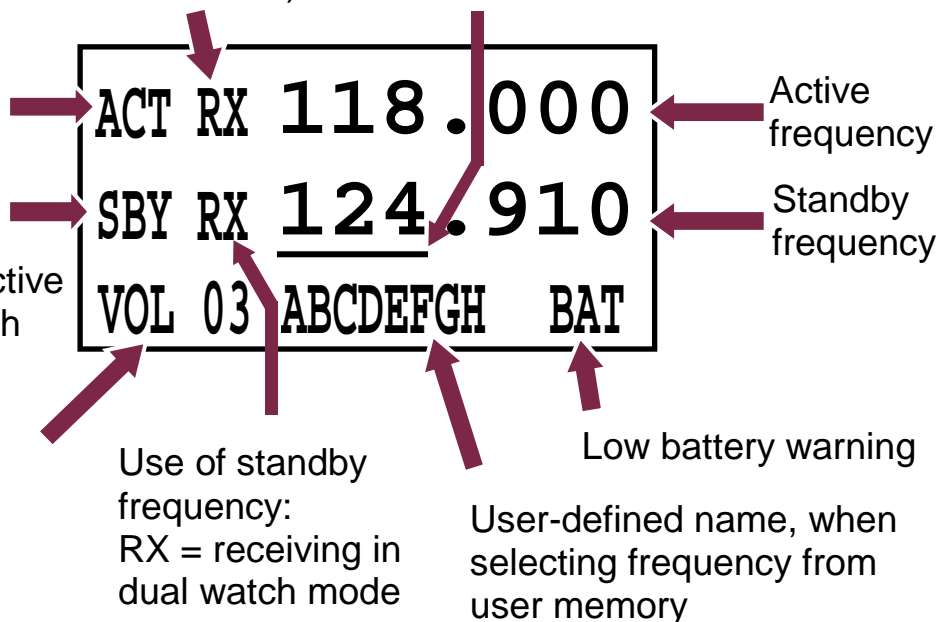

Anzeige	Bedeutung	Bemerkung
ACT	Fixed label for active frequency	
SBY	Label for standby frequency, when no dual watch activated	Dual watch mode allows intermittent monitoring of standby frequency activity
DW	Label for standby frequency, when dual watch mode activated	Dual watch mode allows intermittent monitoring of standby frequency activity
118.000	Active Frequency	Frequency used for transmissions and receptions
124.910	Standby frequency	May be monitored in dual watch mode

Anzeige	Bedeutung	Bemerkung
RX	Receiving on this frequency	Usually on active frequency; can also happen on standby frequency when dual watch activated
TX	Transmitting on active frequency	PTT pressed
Te	Transmission ended automatically after 2 minutes continuous transmission	Release and press again PTT to re-enable transmissions
VOL 03	Volume level for receiving	If SET has been pressed, this display is substituted by other settings
SQL 03	Squelch level	Radio signal strength threshold required for reception; suppresses noise and weak/distant transmitter
DIM 07	Display brightness	
VOX 05	Vox level	Speech level that activates the intercom
DWM -2	Dual watch mute	Reduction in volume for dual-watch-reception on standby frequency
INT 04	Intercom volume	
EXT 02	Volume of external audio-signals	Set to 00, if no external device attached, to prevent noise pickup
MEM 00	Item from user memory	Substitutes standby frequency; can have name, if provided by user. Active frequency can be stored into this entry with long press of MEM
LST 00	Item from list of last used frequencies	Substitutes standby frequency
ABCDEFGH	User-provided name for frequency within user memory	Displayed while selecting from user memory, when the user has provided a name for this specific memory entry

Anzeige	Bedeutung	Bemerkung
BAT	Very low supply voltage	Transmission only with reduced power possible (decreased radio range!)
F1 ... F7	Internal failure	Device must be sent back to the manufacturer

2.4 Basic Settings

To choose between the following settings, use the **SET** button:

0. VOL Volume (chosen by default)
1. SQL Squelch
2. DIM Display Brightness (individually remote control / radio)
3. VOX Speech level required to activate the intercom
4. DWM Dual watch mute
5. INT Intercom volume
6. EXT Volume of external audio signals
- back to Volume

VOL can also be reached by long press of **SET** – or automatically after 12 seconds of inactivity.

The chosen setting can be adjusted by the **VOL / SEL** rotary knob.

The changed settings are directly used within 0.5 seconds at the attached remotely controlled radio. The only exception from this is the display brightness, which is set individually for the remote control unit ATR600RT and the attached radio.

2.4.1 VOL – Volume

Can be reached by a long press of the **SET** button, but is also automatically chosen by the radio after 12 seconds of user inactivity.

Adjusts the volume of received radio signals by turning the **VOL / SEL** knob. The higher the value, the louder the reception of radio signals.

ACT	1 2 3 . 4 5 0
SBY	<u>1 1 8</u> . 9 1 0
VOL	03

↙ Range: 01 – 16



The VOL setting controls the volume of received radio signals only, not the volume of the intercom or the external audio input – these are set separately with INT and EXT.

2.4.2 SQL – Squelch

By shortly pressing the **SET** key once, with the help of the **VOL / SEL** rotary knob the squelch level can be adjusted. (Note: This is not related in any way to the intercom functionality.)

This is a threshold that has to be exceeded by radio signal levels from other transmitters, in order to activate the reception circuitry. The higher the number, the stronger the radio signals have to be in order to be received.

ACT	1 2 3 . 4 5 0
SBY	<u>1 1 8</u> . 9 1 0
SQL	07

↙ Range: 01 - 10

The setting for the squelch depends on different factors. For motor aircrafts an initial higher setting is typically appropriate, gliders may use a lower value. A lower number means higher input sensitivity. This allows reception of weaker signals (radio stations at higher distance), but can also result in pickup of own-aircraft radio interference sources (engine, strobe lights etc.).

	<p>The default Squelch setting is 05. At higher values, weak signals could be suppressed.</p>
---	---

2.4.3 DIM – Display Brightness

By shortly pressing the **SET** key twice, with help from the **VOL/SEL** rotary knob the display's illumination brightness can be adjusted.

ACT	1 2 3 . 4 5 0
SBY	<u>1 1 8</u> . 9 1 0
DIM	0 8

 Range: 01 - 10

This setting is independent from the corresponding setting of the attached remote controlled radio.

2.4.4 VOX – Voice Detection (Speech Threshold for Voice Activated Intercom)

By pressing the **SEL** key twice, with the help of the **VOL** rotary knob, the threshold volume VOX for intercom voice detection can be adjusted. (Note: This is not related in any way to radio reception or squelch.)

VOX defines the crew's speech volume that is required to activate the intercom functionality. The higher the value, the louder you need to speak in order to activate the intercom.

Exception: VOX 01 corresponds to "always on"

The internal filter circuitry has the ability to distinguish between engine noise and speech.

ACT	1 2 3 . 4 5 0
SBY	<u>1 1 8</u> . 9 1 0
VOX	0 5

 Range: 01 - 10

Operation and Installation

In case of very noisy backgrounds or use of uncompensated microphones, the automatic VOX functionality may not work satisfyingly. In these cases, it is possible to deactivate the VOX automatism with VOX 01, and to use an external intercom-switch.

2.4.5 DWM – Dual Watch Volume Reduction

By shortly pressing the **SET** key four times, with help from the **VOL / SEL** rotary knob the lowering of the volume level (“mute”) for receptions on the standby frequency (when having dual watch active) can be controlled. This allows acoustic distinction between both frequencies.

For further information about the dual watch mode see 2.6.

ACT	1 2 3 . 4 5 0
SBY	<u>1 1 8</u> . 9 1 0
DWM	- 2



Range: -8 – 00

-8 is highest muting (dual watch reception at much lower volume)

00 is no muting (dual watch reception at same volume)

2.4.6 INT – Intercom-Volume

The intercom functionality is the onboard crew-internal communication for multiseater aircraft.

By shortly pressing the **SET** key five times, the intercom volume level can be controlled by the **VOL / SEL** rotary knob. The higher the value, the higher the intercom volume.

A change in the intercom volume level also changes the volume of the sidetone. The sidetone is an audible feedback of the own voice to the headset, i.e. you hear yourself speak. This feature supports a natural speech behaviour.

The intercom can be activated in two ways:

- Automatically, i.e. whenever someone speaks into a microphone (i.e. voice activated intercom = VOX, see 2.4.4)

- Manually, i.e. by use of an external intercom switch.

ACT	1 2 3 . 4 5 0
SBY	<u>1 1 8</u> . 9 1 0
INT	0 3

 Range: 01 – 10

2.4.7 EXT – Volume of the External Audio Input

By shortly pressing the **SET** key six times, with help from the **VOL / SEL** rotary knob, the volume from the connected external audio signals (Warning tones, music, etc...) can be set.

The higher the value, the higher the volume of the external audio signal.

A value of 00 deactivates the external audio input.

ACT	1 2 3 . 4 5 0
SBY	<u>1 1 8</u> . 9 1 0
EXT	0 3

 Range: 00 – 10



When no other device is connected to the external audio input, the input should be muted by selecting 00, in order to prevent noise by pickup of on-board interferences.



The priority of the external audio input in comparison to radio receptions can be configured (see 3.3).

2.5 Frequency Setting

Frequency setting is always done by two steps:

1. Entering a new standby frequency to the desired value.
2. Interchanging the new standby frequency and the previous active frequency by using the  key.

Entering a new standby frequency (in the first step) can be done by:

- a) Manual input.
- b) Recall of previously stored frequencies from the user memory (access is limited to the memories 0–9 of the attached radio).
- c) Recall from the list of the last 10 used frequencies.

2.5.1 Automatic 8.33 / 25 kHz Channel Width Selection

Whether a frequency is used with channel width 8.33 kHz or 25 kHz, is automatically determined by the value of the frequency entered, and requires no additional user activity.

The numbering scheme that is used for distinction of the two channel widths is internationally standardised by the ICAO, and consistently used in official documents (like e.g. VFR navigation charts) as well as in the voice phraseology used by ATC radio communication.

Channels used with 25 kHz width are entered in multiples of 25kHz: 123.500, 123.525, 123.550, 123.575, 123.600 etc. These are compatible with the old 25kHz-only radios. To use the same frequencies with 8.33kHz width, the frequency values entered are increased by 5kHz: 123.505, 123.530, 123.555, 123.580, 123.605 etc.

For more detailed information please refer to chapter 5.1– but as said above, for correct channel width selection this knowledge is not required.

2.5.2 Manual Frequency Input

The standby frequency is entered by

- selecting with the  button which part of the frequency to change (marked by underlining), and
- changing the selected part with the **FREQ** rotary knob.

 interchanges the newly set standby frequency and the former active frequency.

	<p>In order to speed up the entering of new frequencies, it is possible to configure the radio to allow entering of those frequencies only that are used with 25 kHz channel width.</p> <p>Please refer to chapter 3.1 for information on this configuration.</p> <p>However, when choosing this option, please keep in mind to re-enable 8.33 kHz channel selection <u>before</u> flying into areas where 8.33 kHz channels are used.</p>
---	--

When having the channel selection configured for 8.33 kHz steps (see 3.1), the frequency is input in three steps:

123.450 → 123.450 → 123.450

When having the channel selection configured for allowing 25 kHz channels only (see 3.1), the frequency is input in two steps:

123.450 ↔ 123.450

2.5.3 Recall a Frequency from the User Memory

To access the user memory frequency list, press **MEM** once, and select from the first 10 of the 100 memory entries with the **VOL / SEL** turn knob.

The selected memory entry substitutes the former standby frequency.

In the lower row of the display, the number of the memory entry selected is indicated by [MEM xx] (with xx = 00 ... 99); if a name has been provided by the user for this memory entry, it is displayed next to the memory entry number.

ACT	1 2 3 . 4 5 0
SBY	<u>1 2 1</u> . 2 7 0
MEM	1 7 HAMBURG

↓
Entry number (Range: 00 – 09)

 interchanges the newly set standby frequency and the former active frequency, and leaves the memory list menu.

If no input is done for 12 Seconds, the device returns to the standard view, too.

If at the attached radio a memory entry within the range 10–99 is selected, what lies outside the direct access by the remote control, the remote control updates the standby frequency, but shows MEM -- for the memory entry.

2.5.4 Recall a Frequency from the List of the 10 Last Used

The ATR833 radio automatically keeps track of the last 10 used active frequencies. To access this list, press **MEM** twice, and select one of the 10 list entries with the **VOL/SEL** turn knob. The selected memory entry substitutes the former standby frequency.

The number of the selected list entry is given in the display's lower row.

ACT	1 2 3 . 4 5 0
SBY	<u>1 1 8</u> . 7 0 0
LST	0 1

↓
Entry number (Range: 00 – 10)



List entry „00“ contains the last standby frequency from the MEM menu.

Key  interchanges the newly set standby frequency and the former active frequency, and leaves the last used list menu.

If no input is done for 12 Seconds, the device returns to the standard view.

2.5.5 Store a Frequency into the User Memory

The active frequency can be stored into any entry of the user memory.

This is achieved by a long press on **MEM** when having selected the user memory entry to be overwritten.

The following example stores the frequency 124.350 MHz of KONSTANZ into the user memory entry 07:

Step	Display (Example)
1. Have the frequency to be stored set <u>as active frequency</u>	ACT 1 2 4 . 3 5 0 SBY <u>1 3 5 . 7 0 0</u> VOL 03
2. <u>Enter memory list:</u> Press MEM once shortly in order to access the user memory. (This overwrites the former standby frequency.)	ACT 1 2 4 . 3 5 0 SBY <u>1 2 2 . 0 0 0</u> MEM 00 KEMPTEN
3. <u>Select the memory position</u> to be used with VOL/SEL	ACT 1 2 4 . 3 5 0 SBY <u>1 2 1 . 2 7 0</u> MEM 07 HAMBURG
4. <u>Overwrite the selected memory entry</u> with a long press of MEM .	ACT 1 2 4 . 3 5 0 SBY <u>1 2 4 . 3 5 0</u> MEM 07

You can now leave the user memory access by pressing **MEM** twice or by waiting for the timeout.

Alternatively, you can **add a name of up to 8 characters to the selected memory entry:**

<p>For giving a name to a user memory, that user memory entry must have been selected. Thus, the following steps directly follow the step 3 or 4 from above.</p> <p>5. <u>Place the cursor into the name field</u> with a long press of ▶</p>	<pre>ACT 124.350 SBY 124.350 MEM 07 _</pre>
<p>6. <u>Enter the name</u> by changing the selected character with FREQ, and advancing the selection with ▶, just as when manually entering a standby frequency.</p>	<pre>ACT 124.350 SBY 124.350 MEM 07 KONSTANZ_</pre>
<p>7. <u>Store the name</u></p> <ul style="list-style-type: none"> • either with a long press of MEM, • or with a long press of ▶. 	<pre>ACT 124.350 SBY 124.350 MEM 07 KONSTANZ</pre>

You can now leave the user memory access by pressing **MEM** twice or by waiting for the timeout.

2.6 Dual Watch Operation

The ATR833 comprises one receiver, therefore DUAL-Watch (simultaneously monitoring two frequencies) is implemented by alternating automatically between the active and the standby frequency.

With dual watch mode active, basically the standby frequency is tuned in, shortly interrupted in regular intervals by tuning in the active frequency for a fraction of a second.

Every then detected radio signal on the active frequency has priority, and pauses the dual watch monitoring of the standby frequency, as long as the reception/transmission continues on the active frequency.

Transmissions are always done one the active frequency.

The dual watch mode is activated by pressing **DW**, and indicated by a changing the “SBY” label for the standby frequency to “DW”.

ACT	1 2 3 . 4 5 0
DW	<u>1 3 5</u> . 7 0 0
VOL	05

The dual watch mode is deactivated by pressing **DW** again, and by any operations changing either of the frequencies.



SQL has to be set to 02 at least, as without proper squelch functionality the radio would not be able to detect whether on the active frequency a reception takes place.

In order to have an audible distinction between receptions on the active and the standby frequency, it is possible to receive the receptions from the standby frequency with a lower volume. Please refer to chapter 2.4.5 for information onto this feature “dual watch volume reduction”.

Quick approach:

- Select or enter a standby frequency which shall be additionally monitored.
- Set SQL with the **SET** key and the **VOL / SEL** rotary knob to a value of at least 02.
- Activate dual watch with **DW** (DW is shown)
- As soon as no reception is determined on the active frequency, the mutual monitoring between active and standby frequency starts.
- To deactivate dual watch: press **DW** again or change the frequency.



Don't forget to interchange the active and standby frequencies, before answering a call on the standby frequency.

2.7 Transmission

By pushing the PTT button, the device starts transmission on the active frequency. The operation of the transmission is indicated by "TX" in front of the frequency used. You can read TX in the Remote-Unit.

ACT TX	1 2 3 . 4 5 0
SBY	<u>1 3 5 . 7 0 0</u>
VOL	05

In order to avoid unintended transmissions, e.g. when having the PTT button stuck ("stuck mic"), the transmitter automatically stops after two minutes of transmission, and „TX“ is substituted by „Te“. You can read Te in the Remote Unit.

In order to re-enable transmission in this case, release PTT and push it again.

2.8 Reception

When receiving, a „RX“ is shown in front of the active frequency. When having dual watch active (see 2.6) this can happen on the standby frequency, too.

ACT RX	1 2 3 . 4 5 0
SBY	<u>1 3 5 . 7 0 0</u>
VOL	05

ACT	1 2 3 . 4 5 0
DW RX	<u>1 3 5 . 7 0 0</u>
VOL	05

3 CONFIGURATION

A **very long press** of **SET** (5 seconds) accesses the configuration menu. The configuration menu is used for fundamental settings.

To choose between the following settings, use the **SET** button:

1. SPC Channel spacing
2. DPY Automatic display darkening
3. EXT Behavior of the external audio input
4. MLS Sensitivity of the left standard microphone input
5. MLD Sensitivity of the left dynamic microphone input
6. MRS Sensitivity of the right standard microphone input
7. MRD ... Sensitivity of the right dynamic microphone input
- Leaving configuration menu / back to VOL
(can also be reached by long press of **SET**)

The chosen setting can be adjusted by the **VOL / SEL** rotary knob.

3.1 SPC – Channel Spacing

With this setting, the ATR833 can be configured to constrain frequency selection to 25 kHz channels only. This can be used to speed up the manual frequency input in areas where no 8.33 kHz channel spacing is used.

See chapter 2.5.2 on further information on manual frequency input.

ACT	1 2 3 . 4 5 0
SBY	1 1 8 . 9 1 0
SPC	8.33 kHz

With the **VOL / SEL** rotary knob the following options can be selected:

- 8.33 kHz Allows input of both 8.33 kHz and 25 kHz channels
- 25 kHz Allows input of 25 kHz channels only.

A short press of **SET** switches to the next configuration item, a long press of **SET** exits the configuration menu.

	<p>This configuration item is <u>not</u> used for determining whether a specific frequency is used with 8.33 kHz or 25 kHz channel width, as this is done by the ATR833 automatically depending onto the frequency value entered.</p> <p>For more details see chapters 2.5.1 and 5.1.</p>
---	---

	<p>Please keep in mind to enable 8.33 kHz channel selection <u>before</u> flying into areas where 8.33 kHz channels are used.</p>
---	---

3.2 DPY – Energy Saving Mode (Automatic Display Darkening)

In order to save energy – and to extend the lifetime of the OLED display – an **automatic display darkening** can be configured.

This setting is done for the remote control and the radio separately.

ACT	1 2 3 . 4 5 0
SBY	1 1 8 . 9 1 0
DPY	always on

With the **VOL/SEL** rotary knob the following options can be selected:

- always on No display darkening at all
- xx min off Automatic darkening after xx minutes of user inactivity (xx = range 1–30)

Reactivation of the darkened display is done by press of any key (except key **I/O**) or turn of any knob (the action of the key pressed is performed when pressing the key again after the display turned on) or when transmitting.

	<p>This feature should only be used when</p> <ul style="list-style-type: none"> • it can be foreseen that no frequency changes will be required (i.e. when using only limited airspace near one airport, e.g. for circuit pattern training flights), and • the crew is familiar with the energy saving mode. <p>In all other cases this feature shall be deactivated, in order to prevent the usage of wrong frequencies and to avoid confusion of pilots not aware of the energy saving mode.</p>
---	--

A short press of **SET** switches to the next configuration item, a long press of **SET** exits the configuration menu.

3.3 EXT – External Audio Input’s Behavior

The external audio input can be used to feed a monaural audio signal to the amplifier for the headsets/speaker.

An external audio signal can be used for different purposes. E.g. it is possible to check the audio signal of a VOR receiver, to attach a traffic sensor with acoustic output, or to use the external audio input for (monaural) music input.

ACT	1 2 3 . 4 5 0
SBY	1 1 8 . 9 1 0
EXT	auto off

As these signals have different priorities in comparison to radio receptions, the priority of the external audio input can be configured.

With the **VOL/SEL** rotary knob the following options can be selected:

always on.....The external audio input is always on, even during radio receptions and transmit mode. Use this setting only for very high priority acoustic warnings, e.g. collision warning beep tones.

auto off.....The external audio input is automatically deactivated during transmit mode, or when no external audio activity is sensed.

not RXTXThe external audio input is automatically deactivated during radio receptions or transmit mode. This

setting does not use the external audio activity sensing, and therefore can introduce noise when no signal source is connected.

Use this setting only when auto off does not react fast enough for very short external audio signals!

A short press of **SET** switches to the next configuration item, a long press of **SET** exits the configuration menu.

3.4 Microphone Input Sensitivity (MLS/MLD/MRS/MRD)

3.4.1 MLS – Standard Microphone Pilot/Left

3.4.2 MLD – Dynamic Microphone Pilot/Left

3.4.3 MRS – Standard Microphone Copilot/Right

3.4.4 MRD – Dynamic Microphone Copilot/Right

	Every microphone input's sensitivity can be individually configured, in order to achieve equal volume with all microphones.
---	---

ACT	1 2 3 . 4 5 0
SBY	1 1 8 . 9 1 0
MLS 04	

ACT	1 2 3 . 4 5 0
SBY	1 1 8 . 9 1 0
MRS 04	

ACT	1 2 3 . 4 5 0
SBY	1 1 8 . 9 1 0
MLD 04	

ACT	1 2 3 . 4 5 0
SBY	1 1 8 . 9 1 0
MRD 04	

The following microphone inputs are available:

Microphone Input	Left	Right
standard (headset)	MLS	MRS
dynamic (glider's gooseneck microphone)	MLD	MRD

Operation and Installation

With **VOX** set to **5** previously, select the microphone to adjust with **SET**.

For each microphone input – if applicable: with running engine – speak with normal volume into the selected microphone, and use the **VOL / SEL** rotary knob to **adjust the sensitivity, so that the bar reaches the middle of the scale**, as depicted above.

A short press of **SET** switches to the next configuration item, a long press of **SET** exits the configuration menu.



For correct microphone sensitivity configuration, **VOX** must be set to 5 previously (for **VOX**-settings refer to section 2.4.4).



Don't care for volume of the headset's/speakers output during this configuration, as this is set separately by **INT**.

4 INSTALLATION

4.1 Advices and Tips

The following suggestions should be considered before installing

The assigned installation company could perform wiring. For diagrams refer to section *4.5 Wiring*.

4.2 Scope of delivery

Part Number	Description
ATR600RT	Remote Control Unit for ATR833 and ATR833A in two-knob versions
ZUB4	2x solid an 2x hollow mounting screws – for panels up to 3mm
BSKS600R3	Cable set for remote control
01.1311.010.71e	User Manual „Operation and Installation“
	EASA Form 1

4.3 Unpacking and Inspecting the Equipment

Carefully unpack the equipment. Damages due to transportation must be reported to the shipping company immediately. Save the shipping container and all packing materials to substantiate your claim

	<p>For storage or reshipment the original packaging should be used.</p>
---	---

4.4 Mounting

- In cooperation with a maintenance shop, location and kind of the installation are specified. The maintenance shop can supply all cables. Suitable sets of cables are available from f.u.n.k.e. AVIONICS GmbH.
- Select a position away from heat sources. Care for adequate convection cooling.
- Leave sufficient space for the installation of cables and connectors.
- Avoid sharp bends and wiring close to control cables.
- Leave sufficient lead length for inspection or repair of the wiring of the connector.
- Bend the harness at the rear connectors to inhibit water droplets (formed due to condensation) from collecting in the connector.
- Remove rotary knobs before mounting:
 - Lift-off caps of the rotary knobs with an appropriate tool
 - Loosen screw and remove rotary knob
 - Insert cap correctly orientated!
- The equipment is fixed front-laterally with four 6-mm through-hole screws in a 57 mm cut-out.
- For mounting details/drawing refer to chapter 4.8.2 Mounting Advices.

4.5 Wiring

4.5.1 Connection Using the Provided Cable Set

Simply connect the d-sub connector to the ATR600RT and the round connector to the mating connector of the remote controlled radio's cable set.

The ATR600RT now gets the power from the remote controlled device; thus it's operation depends onto the operation of the remote controlled device.

4.5.2 Connections Using

Power Supply (Power, GND): AWG18 (0,96 mm²)

Signals: AWG22 (0,38 mm²)

The conductors must be approved for aircraft use.

RX and TX should be shielded individually, or at least be pair-twisted and shielded together.

The light input should

- in aircraft with lighting bus connected to this,
- in the more common case of aircraft without lighting bus connected to the power supply.

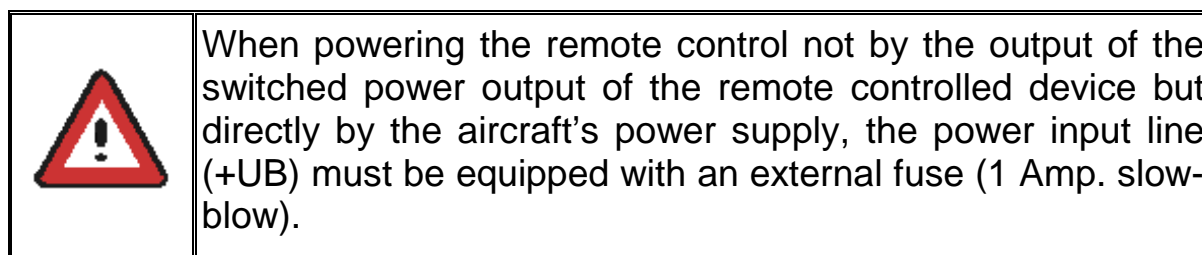

4.5.3 Connector Pin Allocations

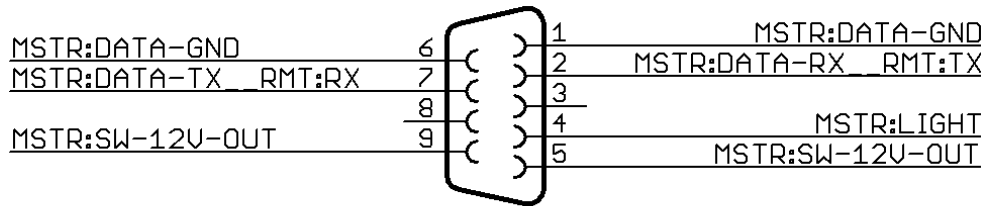

Sub-D Connector Female
seen from solder side

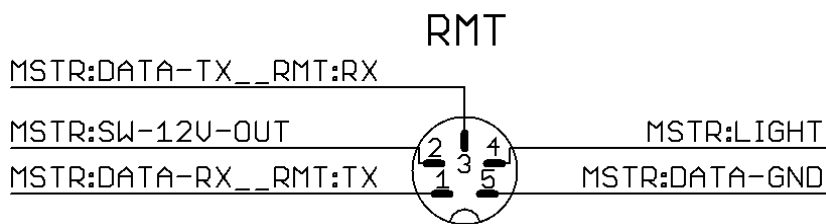

Binder Connector Male
seen from solder side

4.5.4 Wiring Diagram

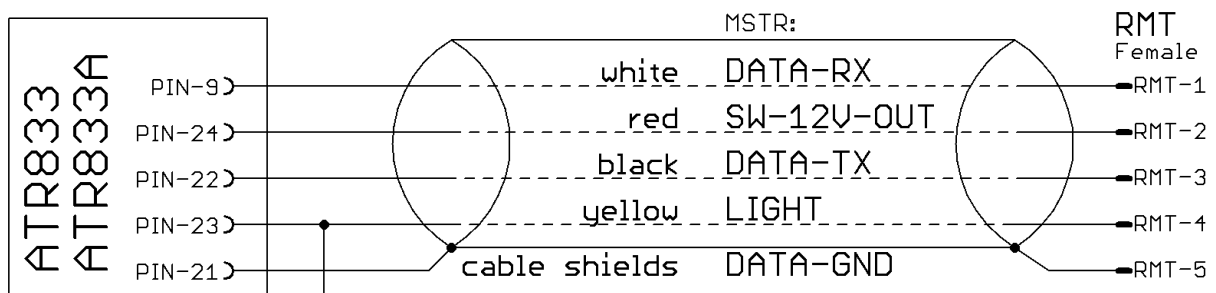
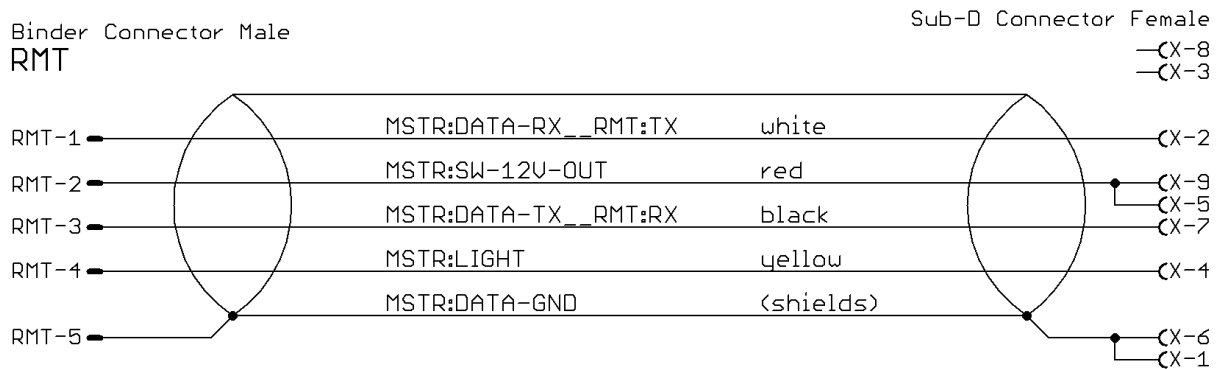

Connect to:

- Lighting Bus +12V..0V
- +12V in Aircraft without Lighting Bus

4.6 Post-Installation Check

When installation is completed all steering and control functions of the aircraft are to be examined, in order to exclude disturbances by the wiring.

For performing an installation check of the remote control, first switch on the remote controlled device, and subsequently the ATR600RT. After the startup-message, which includes the device type, the display should first show the message "SYNCHRONIZING", followed by changing to the normal mode display including the two frequencies, within a few seconds. The remote control is now ready for use.

If instead the message "NO HOST DEVICE DETECTED" appears, it was not possible to establish a connection to the remote controlled device. In this case, the cabling was not done properly, and needs to be fixed.

4.7 Accessories

Suitable accessories like cable sets, connectors or switches can be purchased at our online shop on www.funkeavionics.de.

4.8 Drawings

4.8.1 Dimensions

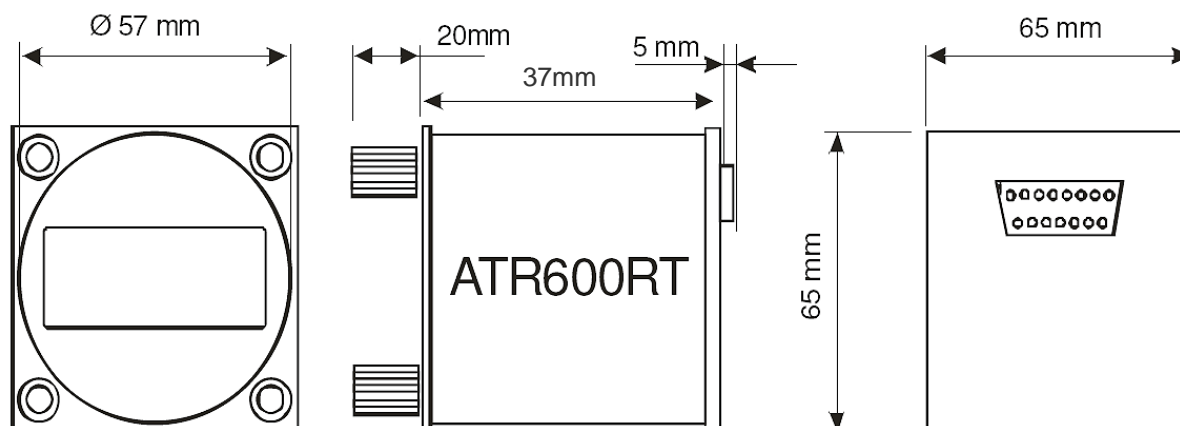

4.8.2 Mounting Advices

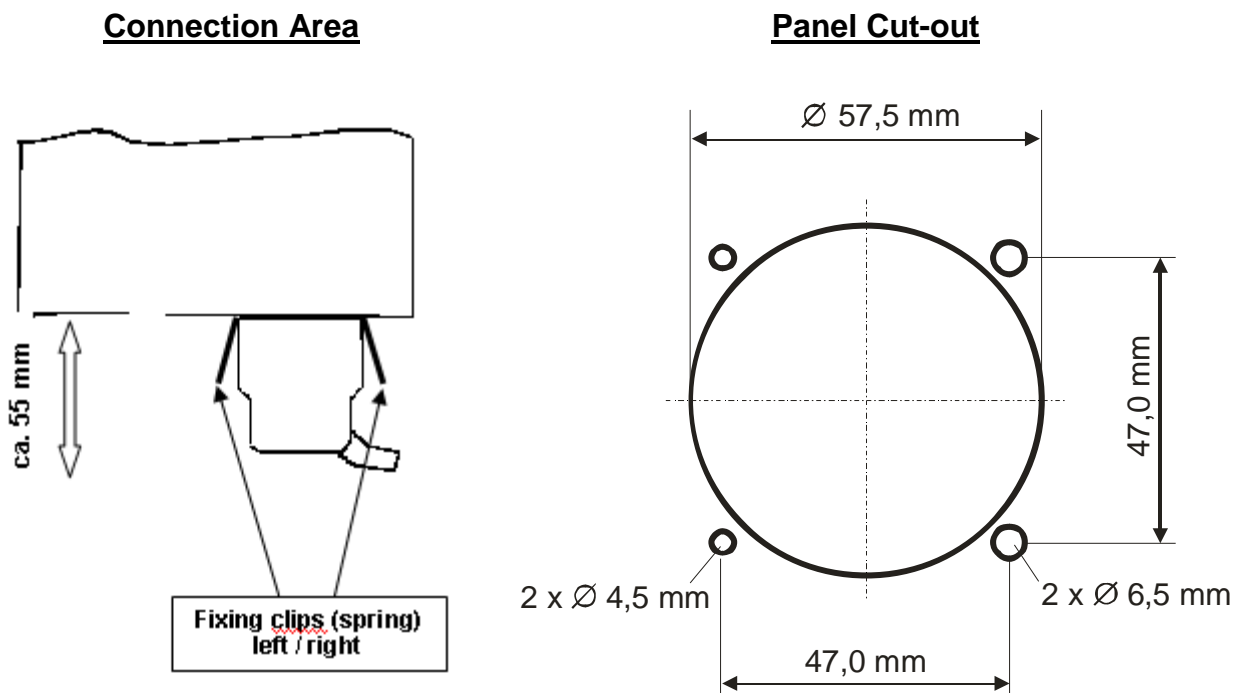

For mounting in panels with a thickness of 3–5 mm longer screws are available:

ZUB5	2x solid und 2x hollow mounting screws for panels 3–5mm
------	---

	No screws may be turned in more than max. 15mm into the device – even if no hard limit is noticeable!
--	--

	The D-SUB-Connector has to be clamped with both spring locks. It is recommended to additionally secure them with a cable tie.
--	---

5 APPENDIX

5.1 Frequency/Channel-Plan

In the following table examples for operating and displayed frequencies in the range between 118.000 ... 118.100 MHz are given. This table can be continued to 136.975 MHz following the same scheme.

Operating Frequency (MHz)	Channel Width (kHz)	Displayed Frequency in 8.33/25 kHz Mode	Displayed Frequency in 25 kHz Mode
118.0000	25	118.000	118.000
118.0000	8.33	118.005	
118.0083	8.33	118.010	
118.0166	8.33	118.015	
118.0250	25	118.025	118.025
118.0250	8.33	118.030	
118.0333	8.33	118.035	
118.0416	8.33	118.040	
118.0500	25	118.050	118.050
118.0500	8.33	118.055	
118.0583	8.33	118.060	
118.0666	8.33	118.065	
118.0750	25	118.075	118.075
118.0750	8.33	118.080	
118.0833	8.33	118.085	
118.0916	8.33	118.090	
118.1000	25	118.100	118.100
118.1000	8.33	118.105	
etc.	etc.	etc.	etc.

5.2 Technical Data

GENERAL	
COMPLIANCE	JTSO-2C37e,ED-23B Class 4, 6 JTSO-2C38e,ED-23B Class C, E TSO-C37d, RTCA DO-186A Class 4, 6 TSO-C38d, RTCA DO-186A Class C, E LBA.O.10.911/115 JTSO
DIMENSIONS	Height: 65 mm (2,56 in) Width: 65 mm (2,56 in) Length: 86 mm (3,27 in) behind the panel
WEIGHT	0.43 lbs (0.20 kg)
MOUNTING	Panel Mounted
TEMPERATURE RANGES OPERATION STORAGE	-20 °C ... +55 °C,30 min at +70 °C -55 °C . . +85 °C
MAX. HEIGHT	35.000ft
VIBRATION	DO-160D, Cat. S, Vibration Curve M
HUMIDITY	RTCA DO-160D, Cat. A
SHOCK	6 G operation 20 G crash safety
RTCA DO-160D ENV.CAT.	[C1Z]CAA[SM]XXXXXXXXZBAAA[YY]M[B3F3]XXA
POWER SUPPLY	13,8 VDC (11 VDC ... 18 VDC) • 60 mA (typ.)
CURRENT CONSUMPTION	600 mW
COMPASS-SAFE DISTANCE	30cm

5.3 Environmental Conditions

Characteristic DO-160D	Section	Cat	Condition
Temperature / Altitude	4.0		
Low ground survival temperature	4.5.1	C1	- 55°C
Low operating temperature	4.5.1		- 20°C
High ground survival Temperature	4.5.2		+ 85°C
High Short-time Operating Temperature	4.5.2		+ 70°C
High Operating Temperature	4.5.3		+ 55°C
In-Flight Loss of Cooling	4.5.4	Z	No auxiliary cooling required
Altitude	4.6.1	C1	35 000 ft
Temperature Variation	5.0	C	2°C change rate minimum per minute
Humidity	6.0	A	
Shock	7.0	A	6 G operational shocks 20 G Crash Safety Test Type R in all 6 directions
Vibration	8.0	S	Vibration Curve M
Explosion Proofness	9.0	X	No test required
Water Proofness	10.0	X	No test required
Fluids Susceptibilities	11.0	X	No test required
Sand and Dust	12.0	X	No test required
Fungus Resistance	13.0	X	No test required
Salt Spray	14.0	X	No test required
Magnetic Effect	15.0	Z	Less than 0,3 m Compass Safe Distance
Power Input (DC)	16.0	B	
Voltage Spike Conducted	17.0	A	

Characteristic DO-160D	Section	Cat	Condition
Audio Frequency Conducted Susceptibility	18.0	A	
Induced Signal Susceptibility	19.0	A	
Radio Frequency Susceptibility	20.0	YY	
Emission of RF Energy	21.0	M	
Lightning Induced Transient Susceptibility	22.0	B3 F3	
Lightning Direct Effects	23.0	X	No test required
Icing	24.0	X	No test required
Electrostatic Discharge (ESD)	25.0	A	

f.u.n.k.e.

AVIONICS GMBH

f.u.n.k.e. AVIONICS GmbH

Heinz-Strachowitz-Str. 4
DE-86807 Buchloe
Germany

phone.: +49-8241 80066 0

fax.: +49-8241 80066 99

E-mail:

service@funkeavionics.de

www.funkeavionics.de